



ИЗВА-МОСК

ПРОИЗВОДСТВО АЛЮМИНИЕВОГО ПРОФИЛЯ

**Каталог
алюминиевых
профилей**

2024г.

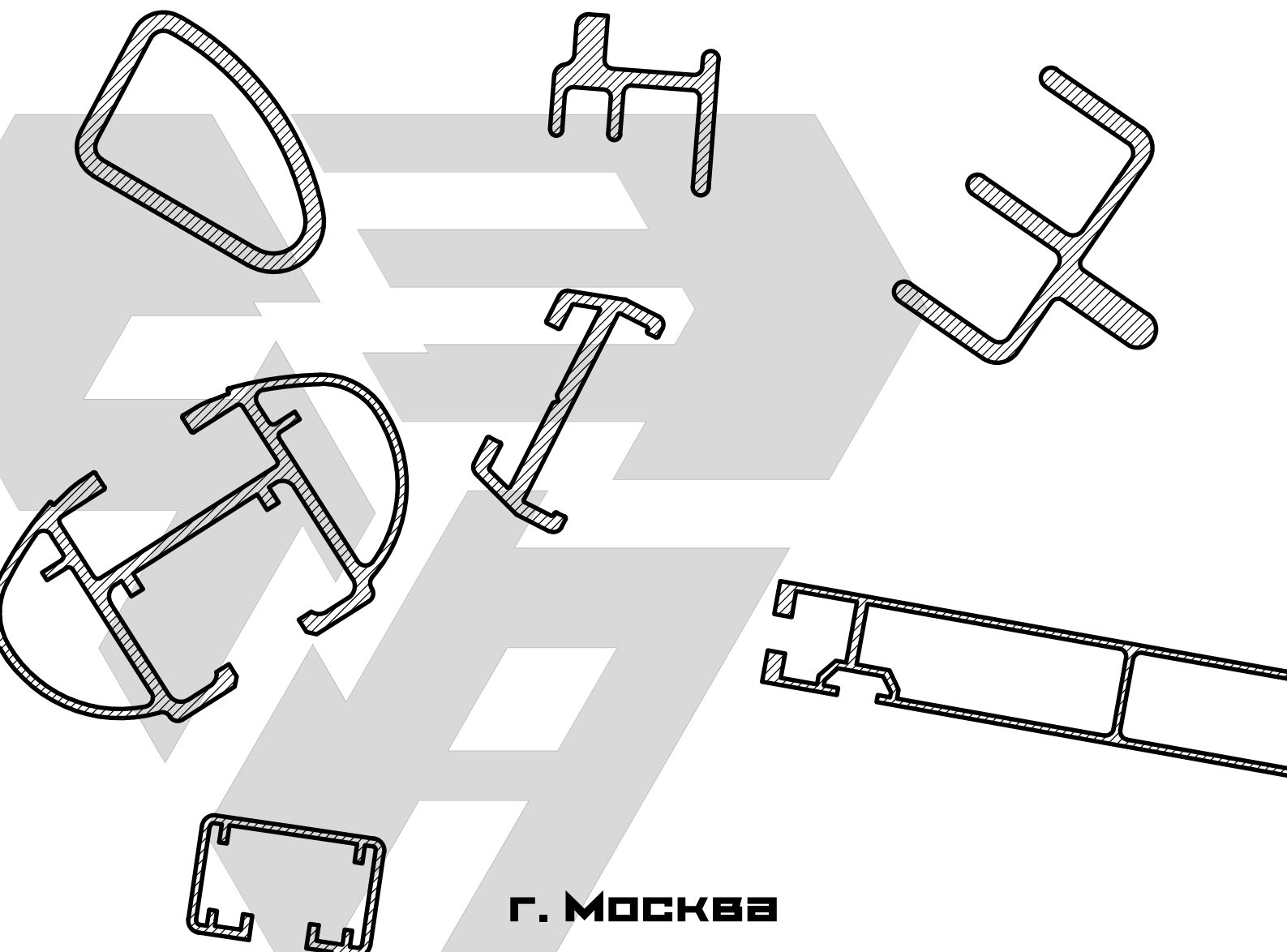

г. Москва

Профили автомобильного назначения



ИЗАР-МСК
ПРОИЗВОДСТВО АЛЮМИНИЕВОГО ПРОФИЛЯ

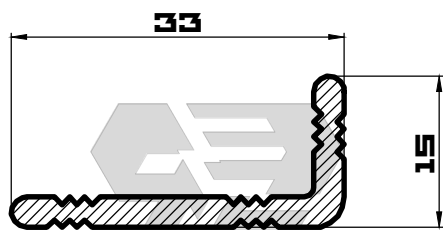

ИЗАР-А001
m=328 (гp/n.m)

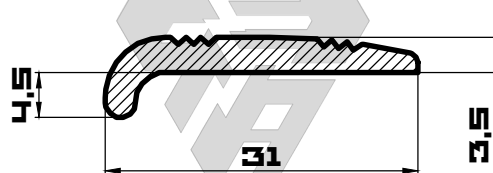

ИЗАР-А002
m=279 (гp/n.m)

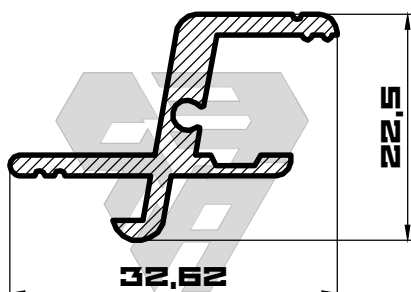

ИЗАР-А003
m=376 (гp/n.m)



ИЗАР-А004
m=1975 (гp/n.m)



ИЗАР-А005
m=2270 (гp/n.m)



ИЗАР-А006
m=2662 (гp/n.m)



ИЗАР-А007
m=2652 (гp/n.m)



ИЗАР-А008
m=2543 (гp/n.m)

Профили автомобильного назначения



ИЗАР-МСК
ПРОИЗВОДСТВО АЛЮМИНИЕВОГО ПРОФИЛЯ

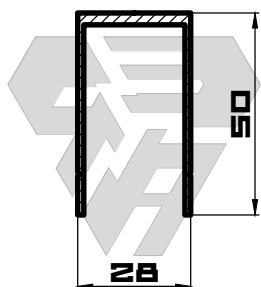

ИЗАР-А009
m=328 (гp/n.m)

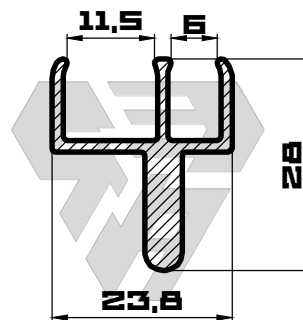

ИЗАР-А010
m=430 (гp/n.m)

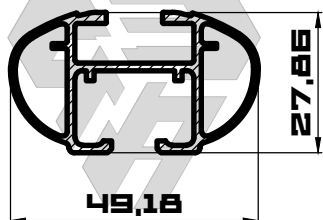

ИЗАР-А011
m=663 (гp/n.m)

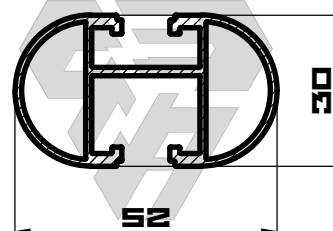

ИЗАР-А012
m=773 (гp/n.m)

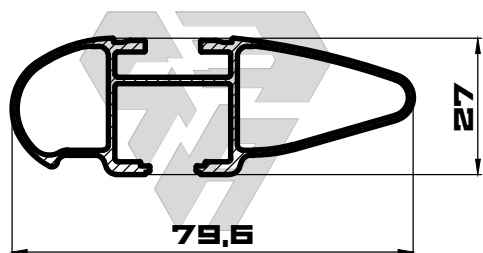

ИЗАР-А013
m=800 (гp/n.m)



ИЗАР-А014
m=1063 (гp/n.m)

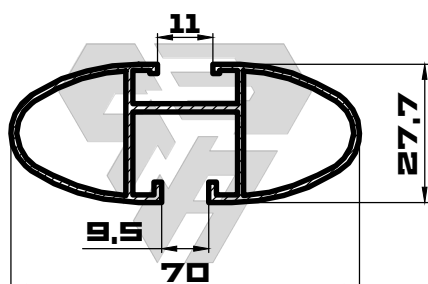

ИЗАР-А015
m=795 (гp/n.m)

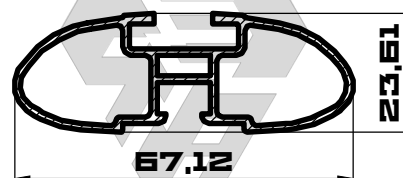

ИЗАР-А016
m=744 (гp/n.m)

Профили автомобильного назначения



ИЗАР-МСК
ПРОИЗВОДСТВО АЛЮМИНИЕВОГО ПРОФИЛЯ

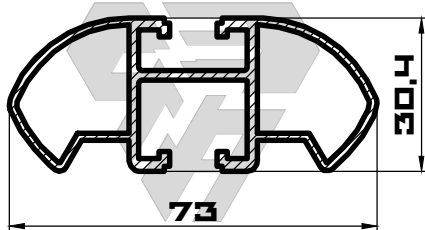

ИЗА-А017
m=1136 (гp/н.м)

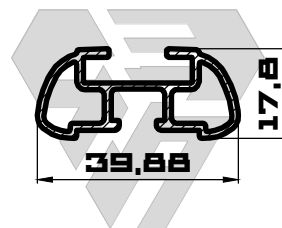

ИЗА-А018
m=879 (гp/н.м)

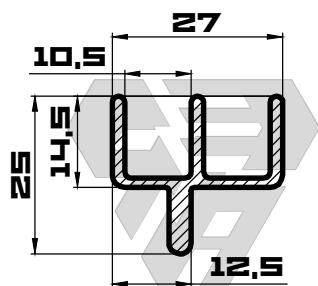

ИЗА-А019
m=412 (гp/н.м)

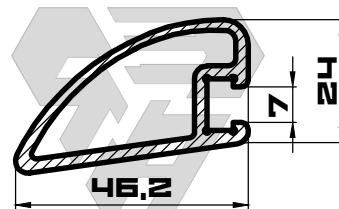

ИЗА-А020
m=815 (гp/н.м)

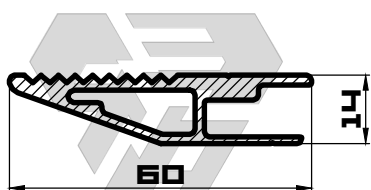

ИЗА-А021
m=846 (гp/н.м)

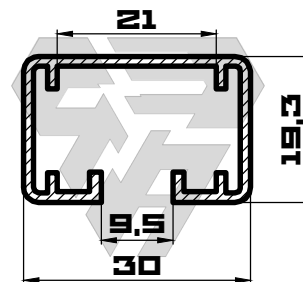

ИЗА-А022
m=2323 (гp/н.м)

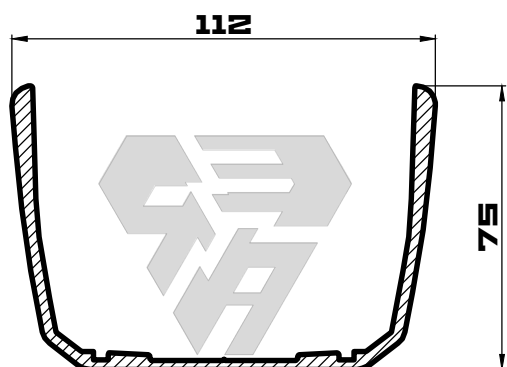

ИЗА-А023
m=2323 (гp/н.м)

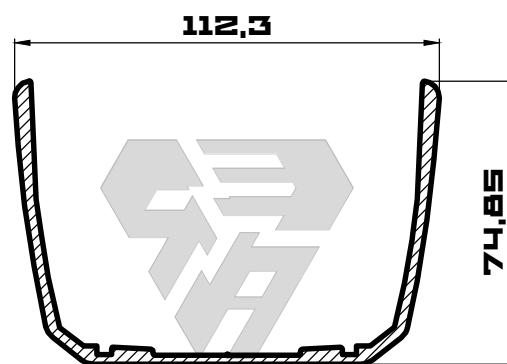

ИЗА-А024
m=2111 (гp/н.м)

Профили автомобильного назначения



ИЗАР-МСК
ПРОИЗВОДСТВО АЛЮМИНИЕВОГО ПРОФИЛЯ

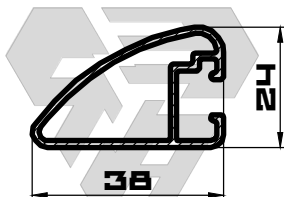

ИЗАР-AD25
m=433 (г/н.м)

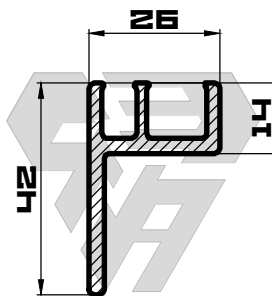

ИЗАР-AD26
m=652 (г/н.м)

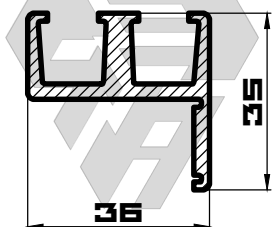

ИЗАР-AD27
m=847 (г/н.м)

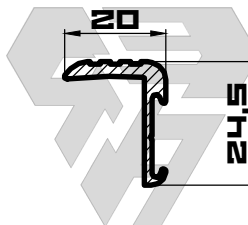

ИЗАР-AD28
m=281 (г/н.м)

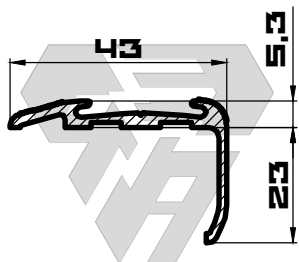

ИЗАР-AD29
m=405 (г/н.м)

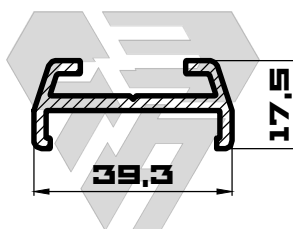

ИЗАР-AD30
m=557 (г/н.м)

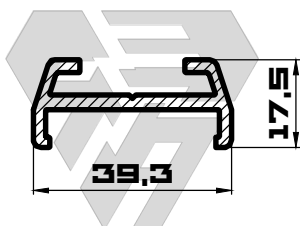

ИЗАР-AD31
m=501 (г/н.м)

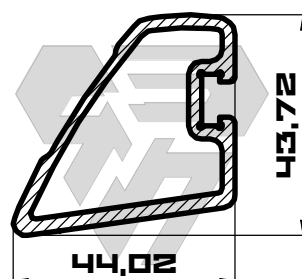

ИЗАР-AD32
m=1060 (г/н.м)

Профили автомобильного назначения



ИЗАР-МСК
ПРОИЗВОДСТВО АЛЮМИНИЕВОГО ПРОФИЛЯ

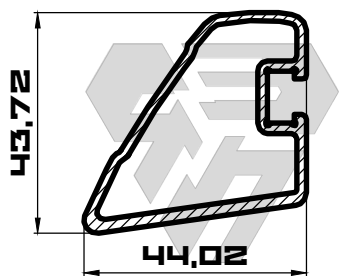

ИЗАР-АD33
m=871 (гp/n.м)

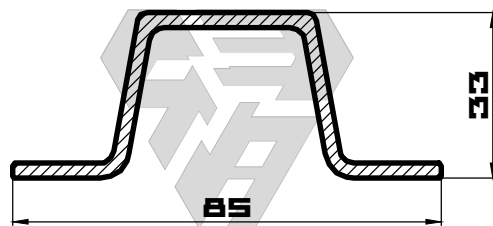

ИЗАР-АD34
m=1083 (гp/n.м)

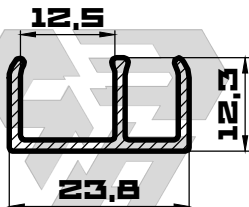

ИЗАР-АD35
m=224 (гp/n.м)

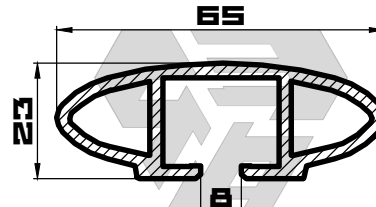

ИЗАР-АD36
m=1156 (гp/n.м)

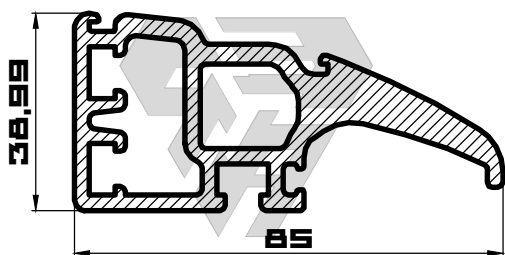

ИЗАР-АD37
m=2775 (гp/n.м)

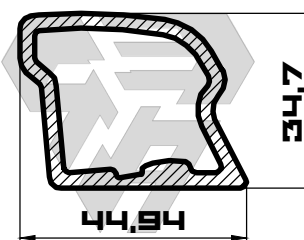

ИЗАР-АD38
m=1142 (гp/n.м)

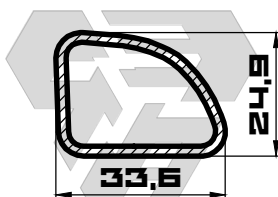

ИЗАР-АD39
m=514 (гp/n.м)

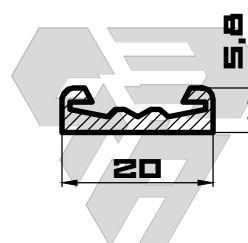

ИЗАР-АD40
m=179 (гp/n.м)

Профили автомобильного назначения



ИЗАР-МСК
ПРОИЗВОДСТВО АЛЮМИНИЕВОГО ПРОФИЛЯ

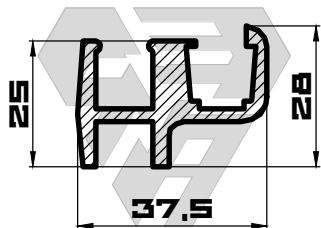

ИЗА-А041
m=901 (г/л.м)

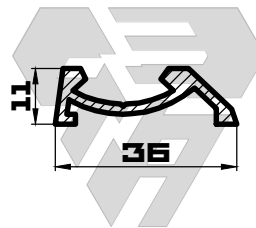

ИЗА-А042
m=356 (г/л.м)

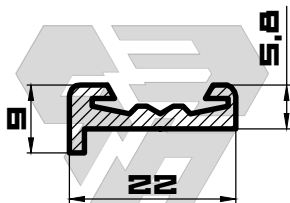

ИЗА-А043
m=277 (г/л.м)

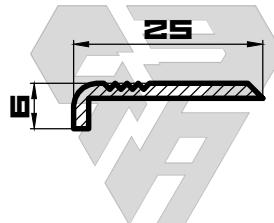

ИЗА-А044
m=140 (г/л.м)

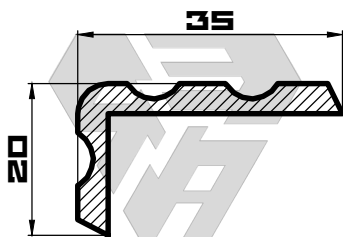

ИЗА-А045
m=442 (г/л.м)

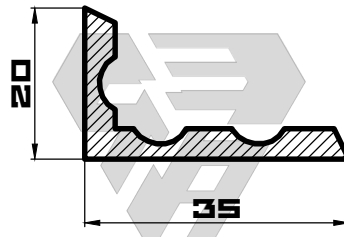

ИЗА-А046
m=451 (г/л.м)



ИЗА-А047
m=668 (г/л.м)

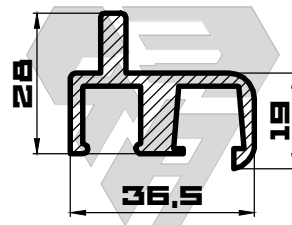

ИЗА-А048
m=669 (г/л.м)

Профили автомобильного назначения



ИЗАР-МСК
ПРОИЗВОДСТВО АЛЮМИНИЕВОГО ПРОФИЛЯ

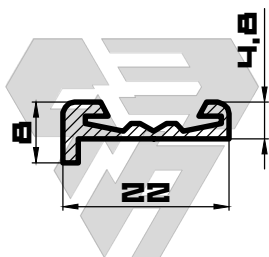

ИЗАР-AD49
m=168 (гг/н.м)

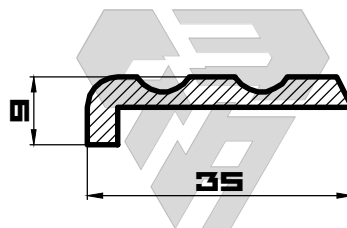

ИЗАР-AD50
m=360 (гг/н.м)

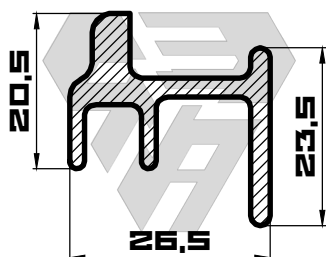

ИЗАР-AD51
m=557 (гг/н.м)

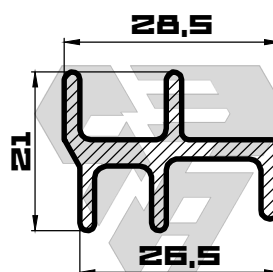

ИЗАР-AD52
m=466 (гг/н.м)

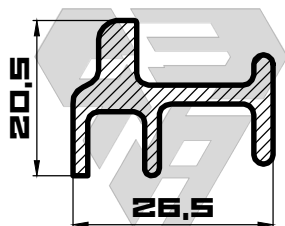

ИЗАР-AD53
m=498 (гг/н.м)

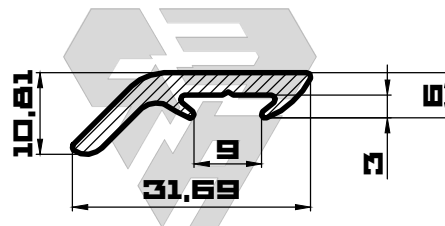

ИЗАР-AD54
m=311 (гг/н.м)

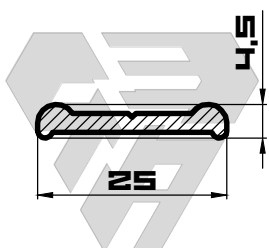

ИЗАР-AD55
m=195 (гг/н.м)

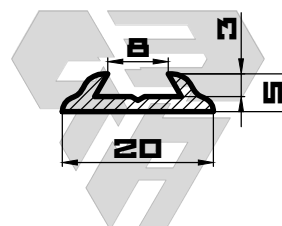

ИЗАР-AD56
m=137 (гг/н.м)

Профили автомобильного назначения



ИЗАР-МСК
ПРОИЗВОДСТВО АЛЮМИНИЕВОГО ПРОФИЛЯ

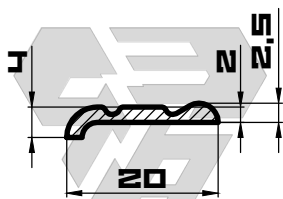

ИЗАР-АD57
m=104 (гp/n.м)

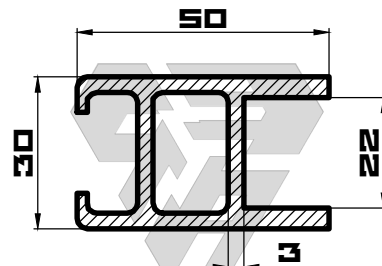

ИЗАР-АD58
m=1353 (гp/n.м)

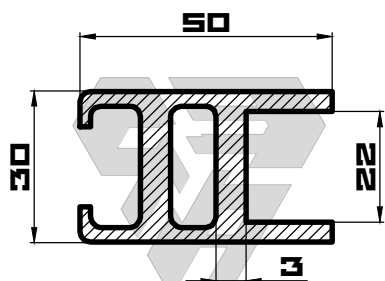

ИЗАР-АD59
m=1743 (гp/n.м)

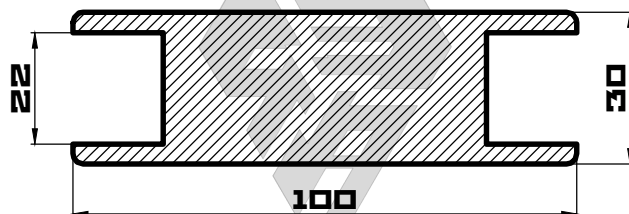

ИЗАР-АD60
m=5975 (гp/n.м)

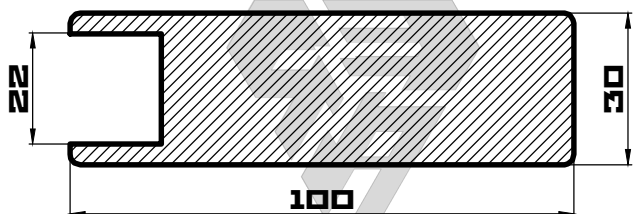

ИЗАР-АD61
m=7047 (гp/n.м)

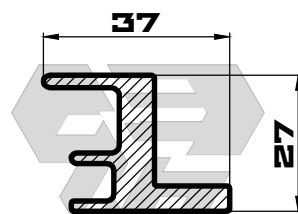

ИЗАР-АD62
m=942 (гp/n.м)

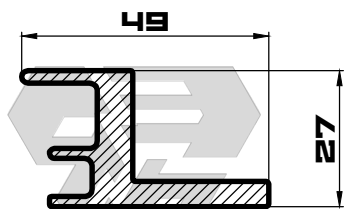

ИЗАР-АD63
m=1105 (гp/n.м)

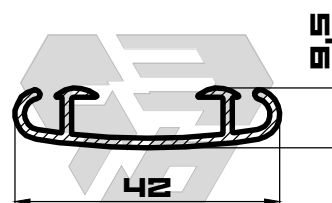

ИЗАР-АD64
m=307 (гp/n.м)

Профили автомобильного назначения



ИЗАР-МСК
ПРОИЗВОДСТВО АЛЮМИНИЕВОГО ПРОФИЛЯ

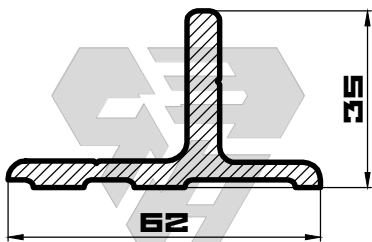

ИЗА-А065
m=1248 (г/н.м)

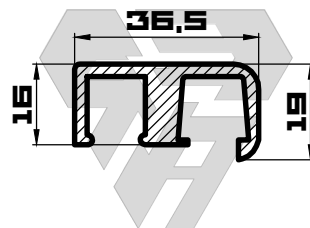

ИЗА-А066
m=708 (г/н.м)

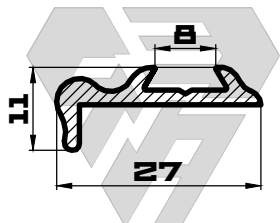

ИЗА-А067
m=227 (г/н.м)

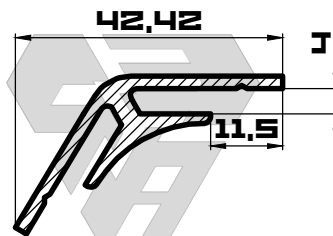

ИЗА-А068
m=491 (г/н.м)

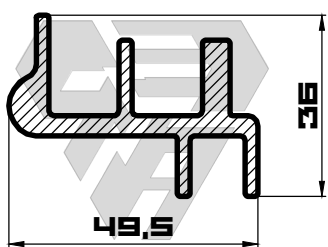

ИЗА-А069
m=1240 (г/н.м)

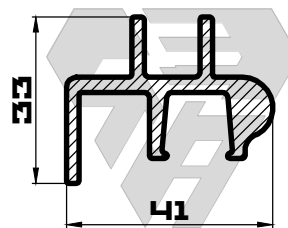

ИЗА-А070
m=926 (г/н.м)

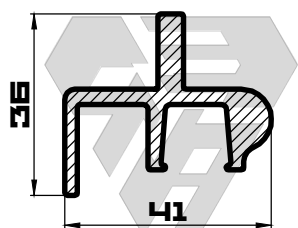

ИЗА-А071
m=1227 (г/н.м)

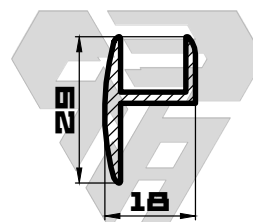

ИЗА-А072
m=329 (г/н.м)

Профили автомобильного назначения



ИЗАР-МСК
ПРОИЗВОДСТВО АЛЮМИНИЕВОГО ПРОФИЛЯ

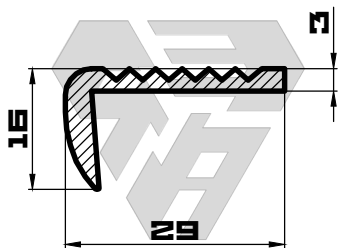

ИЗАР-А073
m=292 (г/л.м)

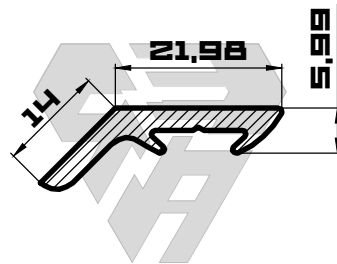

ИЗАР-А074
m=312 (г/л.м)

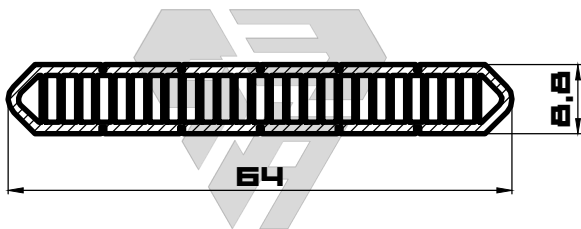

ИЗАР-А075
m=703 (г/л.м)

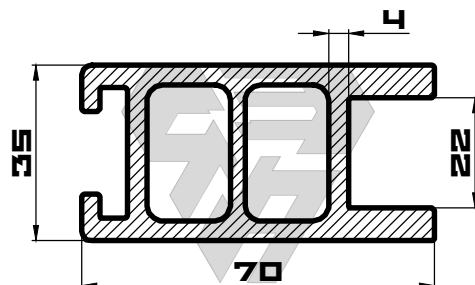

ИЗАР-А076
m=2704 (г/л.м)

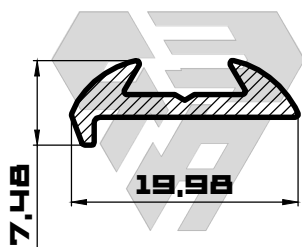

ИЗАР-А077
m=155 (г/л.м)

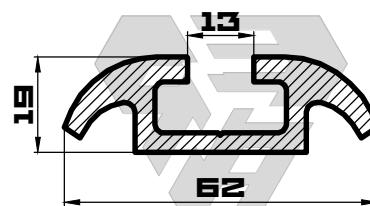

ИЗАР-А078
m=1407 (г/л.м)

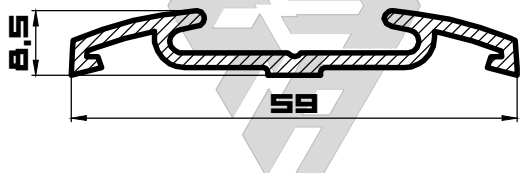

ИЗАР-А079
m=477 (г/л.м)

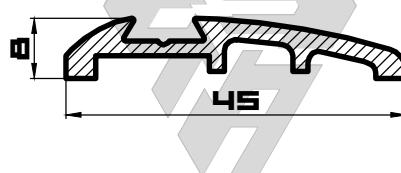

ИЗАР-А080
m=405 (г/л.м)

Профили автомобильного назначения



ИЗАР-МСК
ПРОИЗВОДСТВО АЛЮМИНИЕВОГО ПРОФИЛЯ

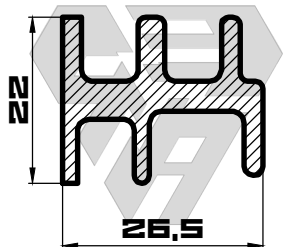

ИЗА-А081
m=669 (гp/n.m)

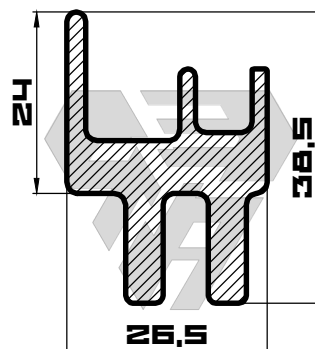

ИЗА-А082
m=1137 (гp/n.m)

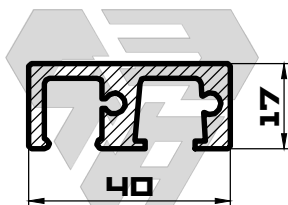

ИЗА-А083
m=859 (гp/n.m)

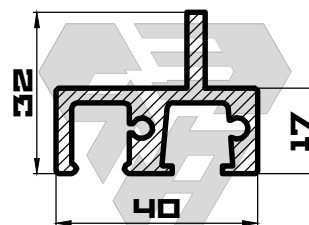

ИЗА-А084
m=1002 (гp/n.m)

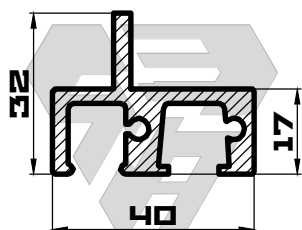

ИЗА-А085
m=1002 (гp/n.m)

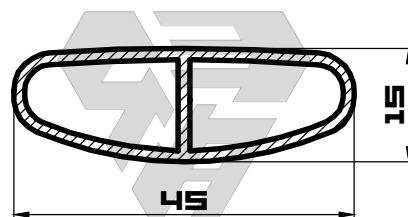

ИЗА-А086
m=453 (гp/n.m)

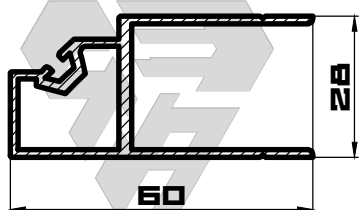

ИЗА-А087
m=794 (гp/n.m)

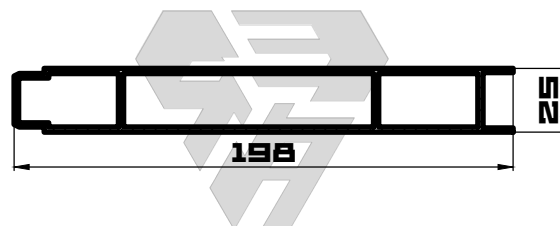

ИЗА-А088
m=2358 (гp/n.m)

Профили автомобильного назначения



ИЗАР-МСК
ПРОИЗВОДСТВО АЛЮМИНИЕВОГО ПРОФИЛЯ



ИЗАР-А089
m=1703 (гp/n.m)



ИЗАР-А090
m=1932 (гp/n.m)



ИЗАР-А091
m=1444 (гp/n.m)



ИЗАР-А092
m=1858 (гp/n.m)

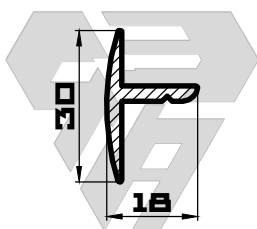

ИЗАР-А093
m=296 (гp/n.m)

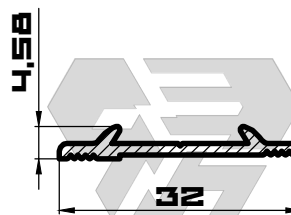

ИЗАР-А094
m=156 (гp/n.m)

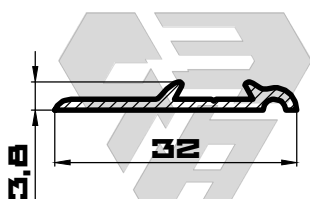

ИЗАР-А095
m=151 (гp/n.m)

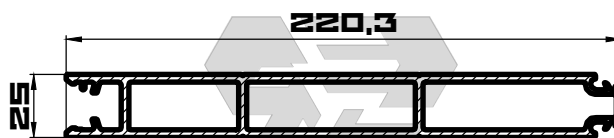

ИЗАР-А096
m=4204 (гp/n.m)

Профили автомобильного назначения



ИЗАР-МСК
ПРОИЗВОДСТВО АЛЮМИНИЕВОГО ПРОФИЛЯ

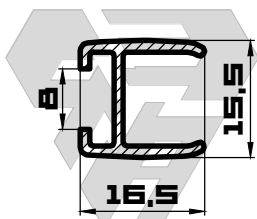

ИЗАР-А097
m=178 (гp/n.m)

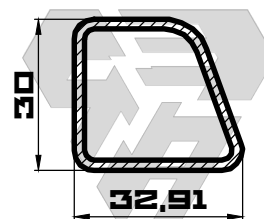

ИЗАР-А098
m=574 (гp/n.m)

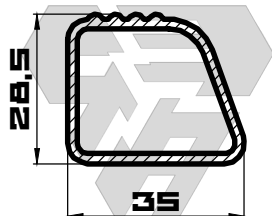

ИЗАР-А099
m=575 (гp/n.m)

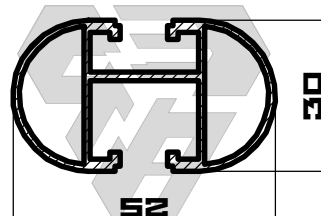

ИЗАР-А100
m=773 (гp/n.m)

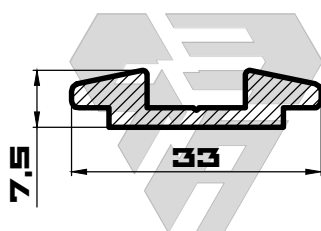

ИЗАР-А101
m=373 (гp/n.m)